

ELEKTRIČNE GREJNE PLOČE

ELECTRIC HEATING PLATES

ЭЛЕКТРИЧЕСКИЕ НАГРЕВАТЕЛЬНЫЕ ПЛИТЫ



www.grejaci.com

Električna grejna ploča – 220x220 četvoropolna sa zaobljenim ivicama

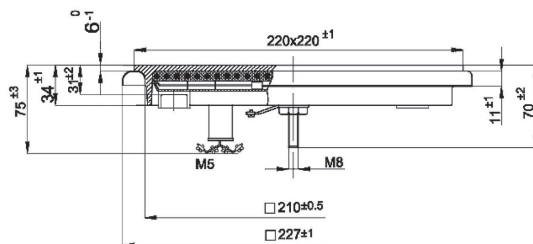
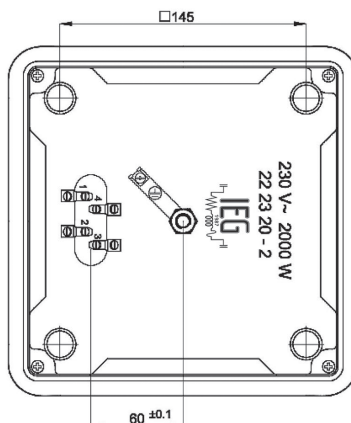

SCHALTSCHEMA
WIRING DIAGRAM
ŠEMA VEZIVANJA

22XX20-2 (2000 W)

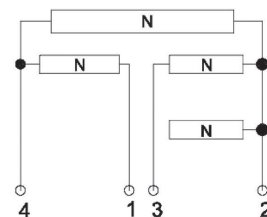

22XX26-21 (2600 W)

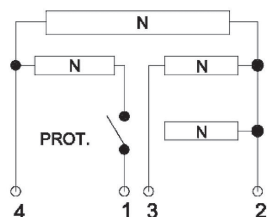

Rb.	Šifra	Stara šifra	Napon V	Snaga W	Parcijalna snaga W	1	2	3	4	5	6
1.	IEGGP301	22 23 20 - 2	230	2000	500	200	330	500	1000	1500	2000
2.	IEGGP302	22 23 26 - 21	230	2600	650	260	430	650	1300	1950	2600
3.	IEGGP303	22 40 20 - 2	400	2000	500	200	330	500	1000	1500	2000
4.	IEGGP304	22 40 26 - 21	400	2600	650	260	430	650	1300	1950	2600

Električna grejna ploča – 300x300 četvoropolna sa oblim ivicama

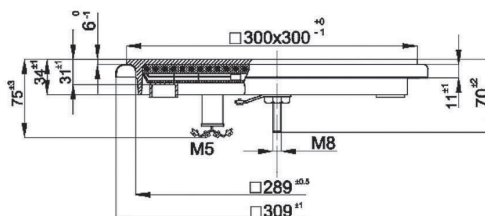
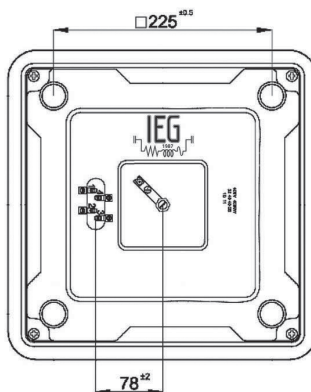

SCHALTSCHEMA
WIRING DIAGRAM
ŠEMA VEZIVANJA

32XX30-21 (3000 W)

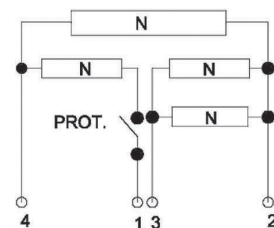

32XX40-21 (4000 W)

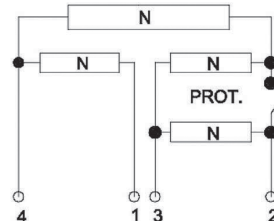

Rb.	Šifra	Stara šifra	Napon V	Snaga W	Parcijalna snaga W	1	2	3	4	5	6
1.	IEGGP401	32 23 30 - 21	230	3000	750	300	500	750	1500	2250	3000
2.	IEGGP402	32 23 40 - 21	230	4000	1000	430	670	1000	2000	3000	4000
3.	IEGGP403	32 24 30 - 21	240	3000	750	300	500	750	1500	2250	3000
4.	IEGGP404	32 24 40 - 21	240	4000	1000	430	670	1000	2000	3000	4000
5.	IEGGP405	32 40 30 - 21	400	3000	750	300	500	750	1500	2250	3000
6.	IEGGP406	32 40 40 - 21	400	4000	1000	430	670	1000	2000	3000	4000
7.	IEGGP407	32 40 30 - 21	440	3000	750	300	500	750	1500	2250	3000
8.	IEGGP408	32 44 40 - 21	440	4000	1000	430	670	1000	2000	3000	4000

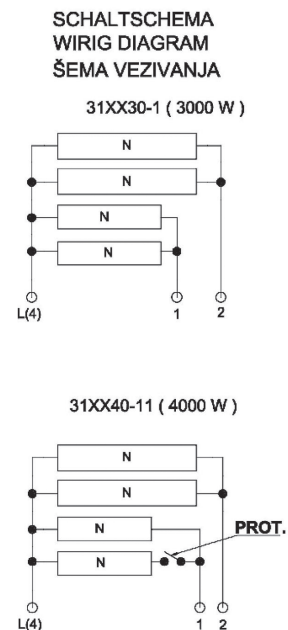
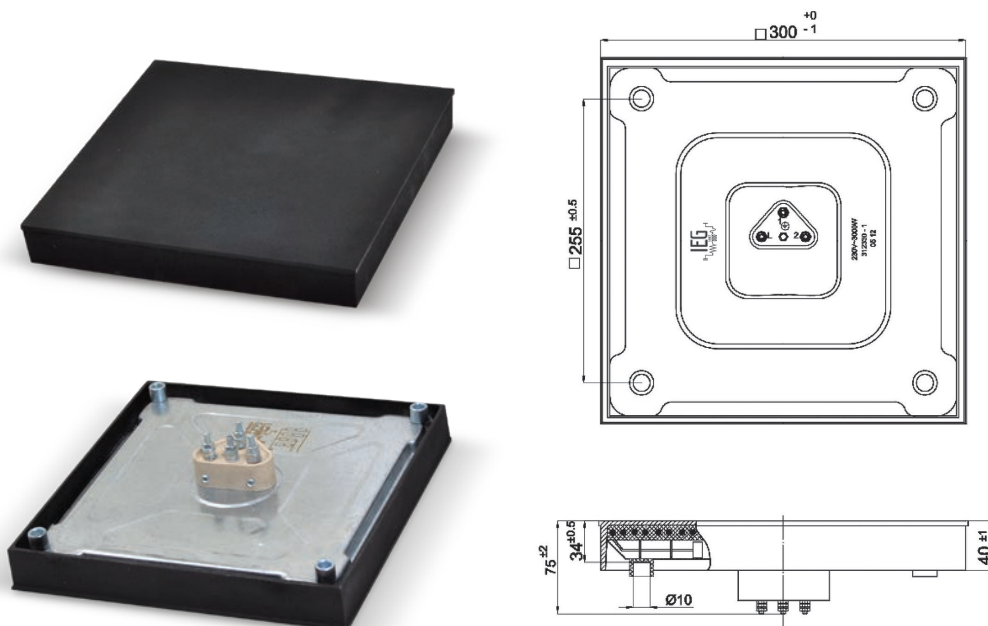

Rb.	Šifra	Stara šifra	Napon V	Snaga W	Parcijalna snaga W	1	2	3
1.	IEGGP101	31 23 30 - 1	230	3000	750	750	1500	3000
2.	IEGGP102	31 23 40 - 11	230	4000	1000	1000	2000	4000
3.	IEGGP103	31 40 30 - 1	400	3000	750	750	1500	3000
4.	IEGGP104	31 40 40 - 11	240	4000	1000	1000	2000	4000

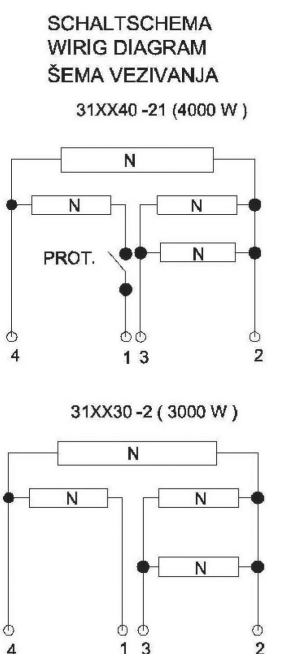
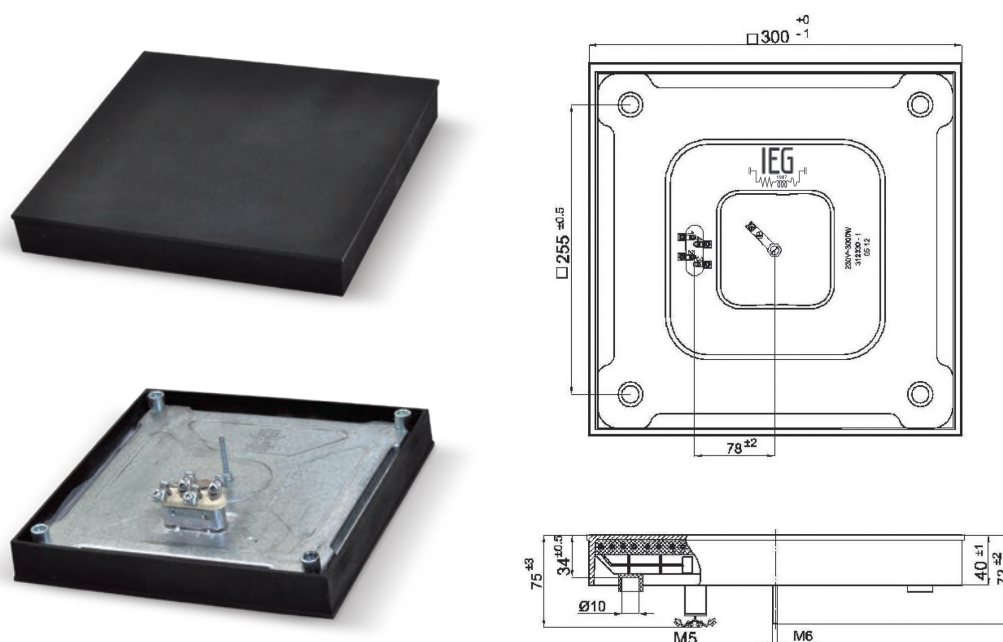

Rb.	Šifra	Stara šifra	Napon V	Snaga W	Parcijalna snaga W	1	2	3	4	5	6
1.	IEGGP501	31 23 30 - 2	230	3000	300	300	500	750	1500	2250	3000
2.	IEGGP502	31 23 40 - 21	230	4000	430	300	670	1000	2000	3000	4000
3.	IEGGP503	31 40 30 - 2	400	3000	300	300	500	750	1500	2250	3000
4.	IEGGP504	31 40 40 - 21	400	4000	430	300	670	1000	2000	3000	4000
5.	IEGGP505	31 23 25 - 2	230	2500	250	300	420	625	1250	1875	2500
6.	IEGGP506	31 44 30 - 2	440	3000	300	300	500	750	1500	2250	3000
7.	IEGGP507	31 44 25 - 2	440	2500	250	300	420	625	1250	1875	2500
8.	IEGGP508	31 40 25 - 2	400	2500	250	300	420	625	1250	1875	2500

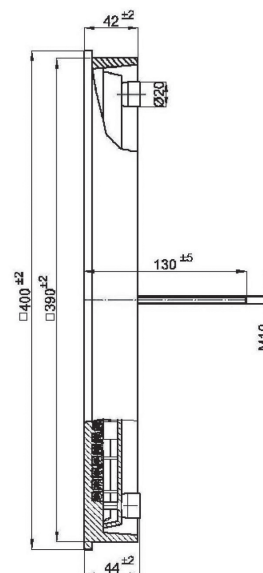
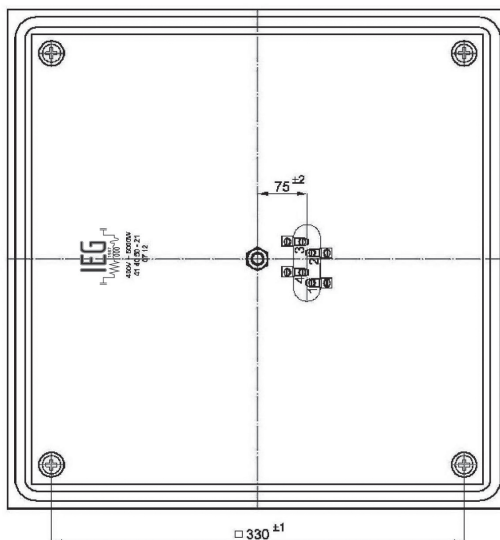
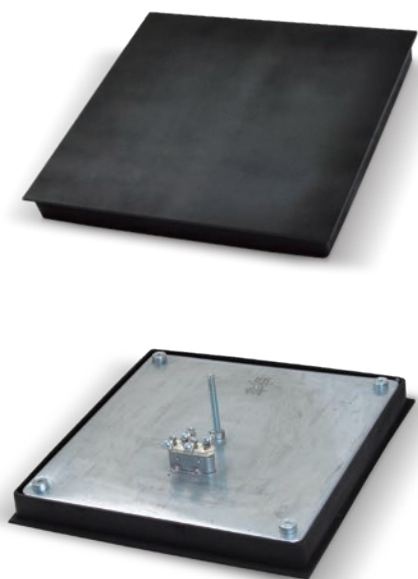

SCHALTSCHEMA
WIRIG DIAGRAM
ŠEMA VEZIVANJA

41XX50 -21 (5000 W)

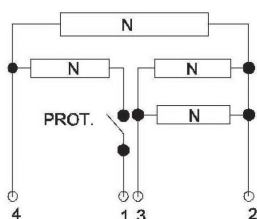

41XX70 -22 (7000 W)

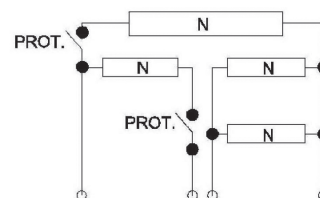

Rb.	Šifra	Stara šifra	Napon V	Snaga W	Parcijalna snaga W	1	2	3	4	5	6
1.	IEGGP201	41 23 50 -21	230	5000	1250	500	840	1250	2500	3750	5000
2.	IEGGP202	41 40 50 - 21	400	5000	1250	500	840	1250	2500	3750	5000
3.	IEGGP203	41 40 70 - 22	400	7000	1750	700	1170	1750	3500	5250	7000

IEG INDUSTRIJA ELEKTRIČNIH GREJAČA

Maloprodaja

Retail

Adresa / Address:

Roze Luksemburg 2a,
Beograd, Rakovica

Tel:

+ 381 11 3582 508
+ 381 11 3581 853

Mob:

+ 381 65 8036 266

Veleprodaja i Proizvodnja

Wholesale and
Manufacturing

Adresa / Address:

Kružni put 40,
Beograd, Leštane

Tel:

+ 381 11 8036 260

Fax:

+381 11 8035 107

Mob:

+ 381 69 8036 260
+ 381 65 80 36 263
+ 381 65 80 36 262
+ 381 64 80 80 980